

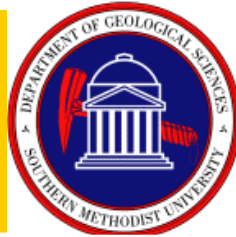

## Technology for the Future of Geothermal Development



June 18, 2008



**UTC Power**

A United Technologies Company



# UTC Power – a UTC Corporation

*Shifting the Paradigm*

*United Technologies: a \$54 billion company (2007)*



**UTC Power**  
Transportation Fuel Cells  
& On-Site Power Solutions



**Pratt & Whitney**  
Aircraft Engines,  
Gas Turbines &  
Space Propulsion



**Carrier**  
Heating, Cooling  
& Refrigeration



**Otis**  
Elevators, Escalators &  
People Moving  
Systems



**Sikorsky**  
Helicopters



**Hamilton Sundstrand**  
Aerospace & Industrial



**UTC Fire & Security**  
Security &  
Fire Protection



**UTC Research Center**  
Technology  
Advancement



**UTC Power**

A United Technologies Company



# Benefits of Geothermal Power

## *Shifting the Paradigm*

- Energy independence – national priority
  - Improves our energy security and reduces dependence on foreign oil
- Environmentally friendly - provides clean and safe energy
  - Is renewable and sustainable
  - Zero emissions
- Generates continuous, reliable “baseload” power
- Cost competitive
- Conserves fossil fuels and contributes to diversity in energy sources
- Modular technology allows incremental development at remote sites
- Small powerplant footprint and little environmental impact
- Government mandates and incentives
  - Significant government mandates for green power
  - Attractive tax incentives



**UTC Power**

A United Technologies Company



# Equivalent Emissions Reduction

*Shifting the Paradigm*

## *Avoided emissions for a 1.0 MW system*

	Annual Avoided CO <sub>2</sub> Emissions		Annual Avoided NO <sub>x</sub> Emissions	
	Tons	Equivalent acres of forest*	Tons	Equivalent number of cars**
<b>PureCycle® system</b> <i>(95% availability)</i>	<b>6,045</b>	<b>1,270</b>	<b>10.80</b>	<b>570</b>
Wind <i>(25% availability)</i>	<b>1,585</b>	<b>335</b>	<b>2.86</b>	<b>150</b>
Solar <i>(14% availability)</i>	<b>885</b>	<b>185</b>	<b>1.60</b>	<b>85</b>

\* Each acre of forest assumed to absorb 1.3 tons Carbon/acre/year (Ref: International Panel on Climate Change)

\*\* Each car assumed to generate 38 lbm/NOx/year (Ref: US EPA)

Assumes full heat utilization





# PureCycle<sup>®</sup> Power System

*Shifting the Paradigm*

## Organic Rankine Cycle

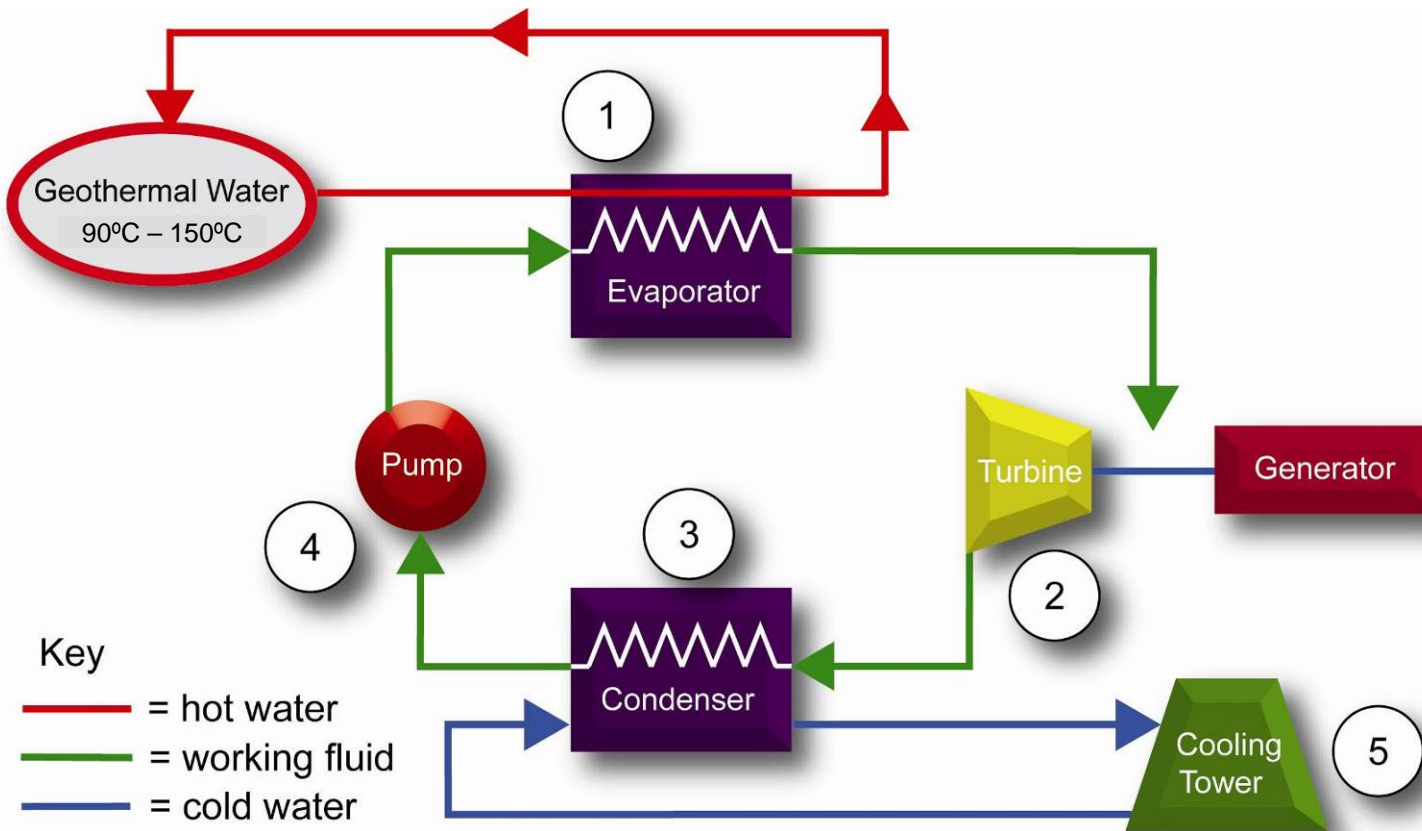



# HVAC Component Synergy

*Shifting the Paradigm*

## Turbine Generator

### Vapor Compression Cycle (VCC)

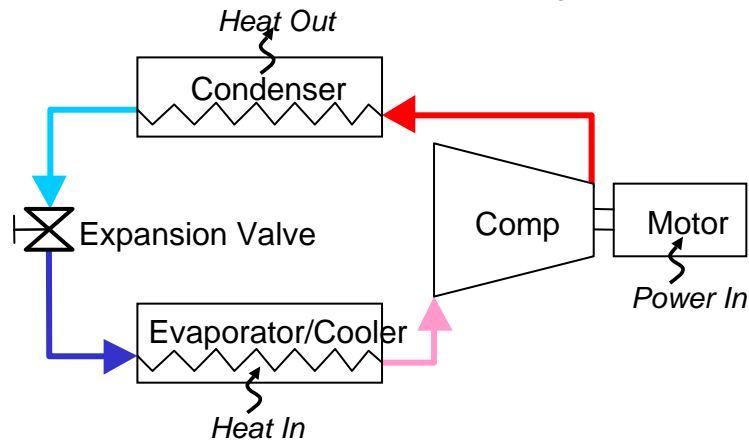

### Organic Rankine Cycle (ORC)

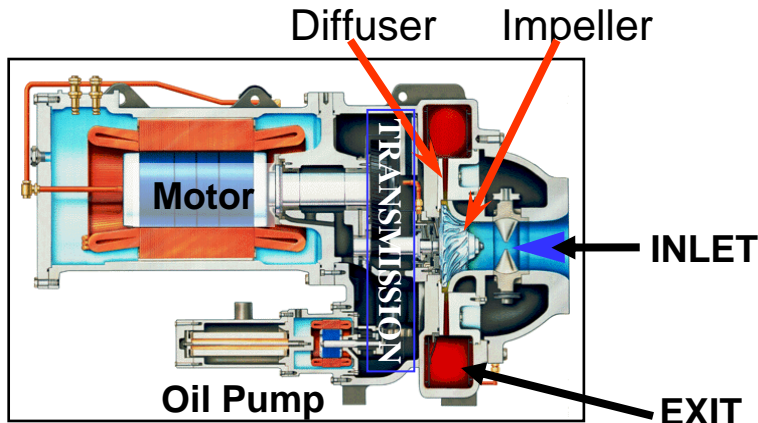
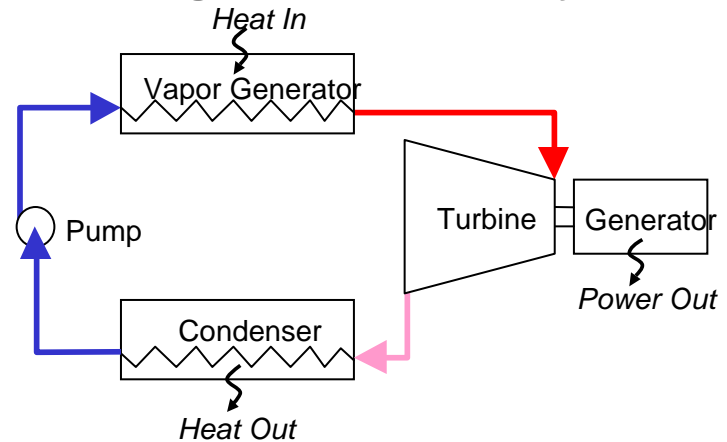

Centrifugal Compressor

### Required Modifications

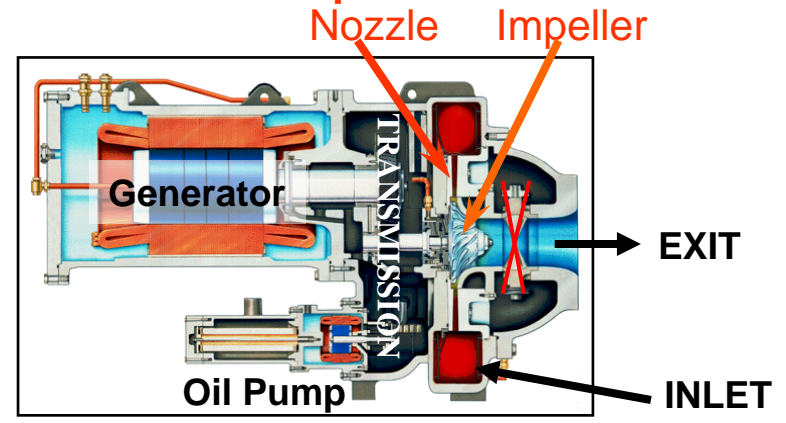

Radial Expansion Turbine



# Technology Demonstration

*Shifting the Paradigm*

## Chena Hot Springs

*1<sup>st</sup> unit commissioned July 2006*

*2<sup>nd</sup> unit December 2006*

*74°C hot water resource*

*4 – 7°C cooling water available*

*Drivers: Off-Grid, base load sustainable  
geothermal power*



**UTC Power**

A United Technologies Company



*Shifting the Paradigm*

## ***UTC Passport process is foundation for product development activity***

- **Disciplined and structured process used across each UTC division**
- **Focus on risk management and gated control**
- **Standard work, process tools, lessons learned, and checklists**
- **Exit criteria: proven product that meets or exceeds customer requirements for quality, reliability, and life cycle costs**



**UTC Power**

A United Technologies Company



# Top Level Assembly



*Shifting the Paradigm*

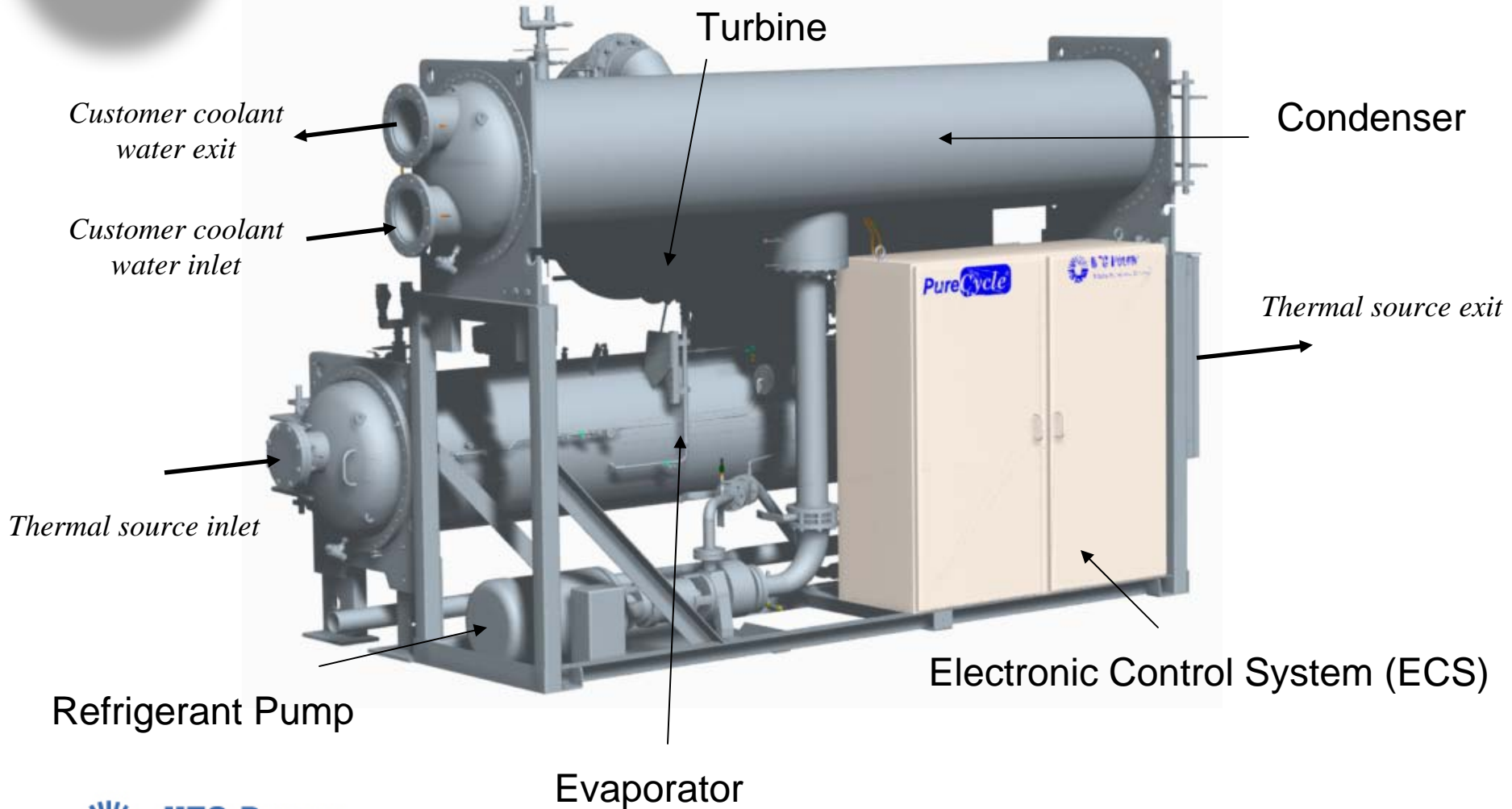



# Production Units

*Shifting the Paradigm*



**UTC Power**

A United Technologies Company





# Raser Update

*Shifting the Paradigm*

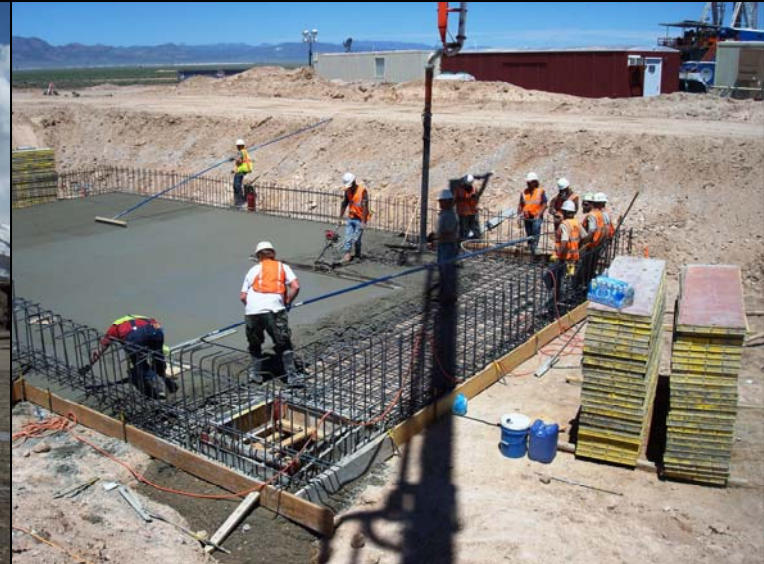



# PureCycle® Power System

*Shifting the Paradigm*

## Raser Technologies' Rapid Deployment Strategy



**UTC Power**

A United Technologies Company





# PureCycle® Product Attributes

*Shifting the Paradigm*

**Off-the-shelf production; rapid deployment**

**Low to moderate temps**

**Low cost modular skid**

**Full remote control**

**- No equipment operators required**

**Full service contracts**

**High power plant availability**



**UTC Power**

A United Technologies Company



*Shifting the Paradigm*

**Production ramp up for Model 280 system**  
**Larger unit product development**  
**Advanced low temperature development**  
**Oil & Gas, industrial applications**  
**International markets**



**UTC Power**

A United Technologies Company



*Shifting the Paradigm*



**Thank you**

Ed Fichtel  
*Product Manager*  
*PureCycle<sup>®</sup> Power System*



**UTC Power**

A United Technologies Company